

SPICE thermal model

BUK964R2-80E

Symbol	Parameter	Conditions	Min	Typ	Max	Unit
$R_{th(j-mb)}$	thermal resistance from junction to mounting base		-	-	0.43	K/W

C_{th1}	2.727E-04 F
C_{th2}	1.961E-03 F
C_{th3}	1.472E-03 F
C_{th4}	5.515E-03 F
C_{th5}	1.889E-02 F
C_{th6}	3.370E-02 F
C_{th7}	7.373E-01 F
C_{th8}	2.812E+02 F
R_{th1}	3.269E-04 Ω
R_{th2}	6.428E-04 Ω
R_{th3}	7.505E-03 Ω
R_{th4}	1.817E-02 Ω
R_{th5}	6.176E-02 Ω
R_{th6}	2.678E-01 Ω
R_{th7}	7.287E-02 Ω
R_{th8}	6.467E-04 Ω

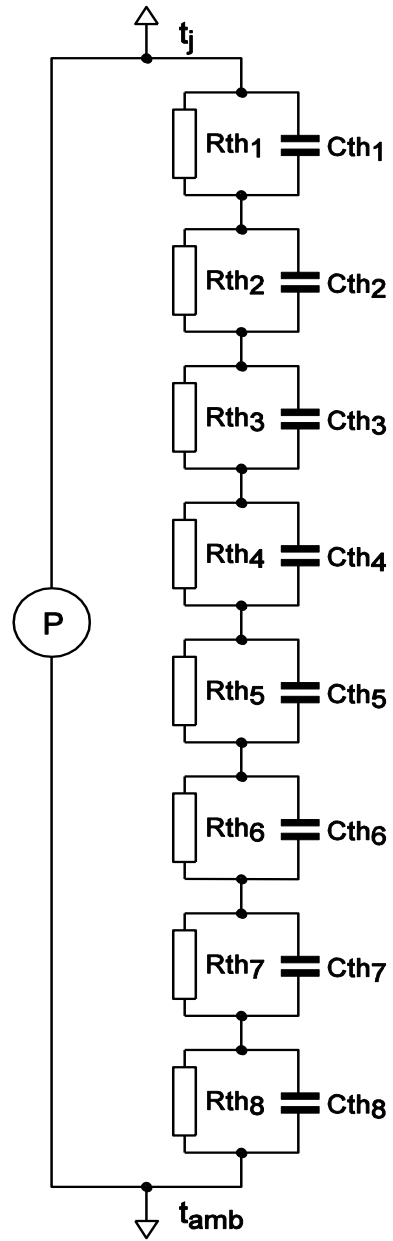

Part: BUK964R2-80E
 Date: 11/4/2013
 Model Rth 0.43 K/W